

## Datasheet - AZM 170-02ZRKA 230 VAC

Solenoid interlock / AZM 170



- thermoplastic enclosure
- Double-insulated
- Compact design
- 90 mm x 84 mm x 30 mm
- 1 Cable entry M 20 x 1.5
- Interlock with protection against incorrect locking.
- Long life
- High holding force
- IDC method of termination
- Manual release

(Minor differences between the printed image and the original product may exist!)

### Ordering details

Product type description	AZM 170-02ZRKA 230 VAC
Article number	1136316
EAN code	4030661056210

### Approval

Approval

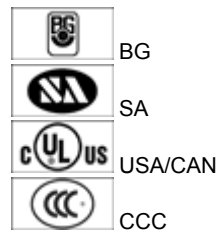

### Classification

Standards	EN ISO 13849-1
B <sub>10d</sub> Opener (NC)	2.000.000
Mission time notice	20 Years
	$MTTF_d = \frac{B_{10d}}{0,1 \times n_{op}}$
	$n_{op} = \frac{d_{op} \times h_{op} \times 3600 \text{ s/h}}{t_{zyklus}}$

### Global Properties

Product name	AZM 170
Standards	EN 60947-5-1, BG-GS-ET-19
Compliance with the Directives (Y/N) 	Yes
Number of actuating directions	2 piece
Active principle	electromechanical
Duty cycle	Magnet 100 %
Materials	
- Material of the housings	Plastic, glass-fibre reinforced thermoplastic, self-extinguishing
- Material of the contacts	Silver
Housing coating	None
Weight	278 g

### Mechanical data

Design of electrical connection	IDC method of termination
Cable section	
- Min. Cable section	1 x 0,75 mm <sup>2</sup>
- Max. Cable section	1 x 1.0 mm <sup>2</sup> , flexible
Mechanical life	> 1.000.000 operations
Emergency unlocking device (Y/N)	No
- bottom	
Manual release (Y/N)	Yes
Emergency release (Y/N)	No
Latching force	30 N
Positive break force	17 N
positive break travel	11 mm
Clamping force F <sub>max</sub>	1000 N
Max. Actuating speed	2 m/s

### Ambient conditions

Ambient temperature	
- Min. environmental temperature	- 25°C
- Max. environmental temperature	+ 60°C
Protection class	IP67 to IEC/EN 60529

### Electrical data

Design of control element	Opener (NC)
Switching principle	Creep circuit element
Number of auxiliary contacts	0 piece
Number of safety contacts	2 piece
Power to unlock	No
Power to lock	Yes
Rated control voltage U <sub>s</sub>	230 VAC
Power consumption	max. 10 W
Rated impulse withstand voltage U <sub>imp</sub>	4 kV
Rated insulation voltage U <sub>i</sub>	250 V
Thermal test current I <sub>the</sub>	10 A
Utilisation category	AC-15: 230 V / 4 A, DC-13: 24 V / 4 A
Max. fuse rating	6 A gG D-fuse

### ATEX

Explosion protection categories for gases

None

Explosion protected category for dusts

None

### Miscellaneous data

Applications



sliding safety guard,



removable guard,



hinged safety guard

### Dimensions

Dimensions of the sensor

- Width of sensor	90 mm
- Height of sensor	84 mm
- Length of sensor	30 mm

### notice

This type termination (IDC) method enables simple connection of flexible conductors without the need for the use of conductor ferrules

Individual coding available on request

Manual release

- For manual release using M5 triangular key, available as accessory

### Diagram

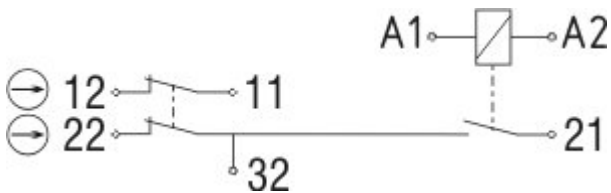

Note Diagram

positive break NC contact

active

no active

Normally-open contact

Normally-closed contact

### Switch travel diagram

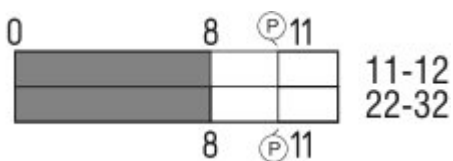

Notes Switch travel diagram

Contact closed

Contact open

Setting range

- Ⓛ Break point
- Ⓟ Positive opening sequence/- angle
- VS** adjustable range of NO contact
- VÖ** adjustable range of NC contact
- N** after travel

## Ordering suffix

The applicable ordering suffix is added at the end of the part number of the safety switch.

Order example: AZM 170-02ZRKA 230 VAC-**1637**

---

...-**1637** With gold-plated contacts (0,3 µm), ordering suffix -1637

---

...**ST-2431** connector M12 , Individual solenoid monitoring

---

## Ordering code

AZM 170(1)-(2)Z(3)K(4)-(5)-(6)-(7)

(1)

*without* IDC method of termination

**SK** Screw connection

(2)

**11** 1 Normally open contact (NO) / 1 Opener (NC)

**02** 2 Opener (NC)

**12/0.0** 1 Normally open contact (NO), 2 Opener (NC) / -

(3)

*without* Latching force 5 N

**R** Latching force 30 N

**I** Individual coding

(4)

*without* Power to unlock

**A** Power to lock

(5)

*without* cable gland

**ST** Connector M12 x 1

**ST-2431** Connector M12 x 1, Individual solenoid monitoring

(6)

**24VAC/DC** U<sub>s</sub> 24 VAC/DC

**110VAC** U<sub>s</sub> 110 VAC

**230VAC** U<sub>s</sub> 230 VAC

(7)

*without* Manual release

**2197** Manual release from side (Power to unlock)

**1637** gold-plated contacts

**AZM 170ST and AZM 170SK**

**AZM 170ST-(1)Z(2)K(3)-(4)-(5)-024**

**AZM 170SK-(1)Z(2)K(3)-(4)-(5)-024**

(1)

**11/11** 1 Normally open contact (NO), 1 Opener (NC) / 1 Normally open contact (NO), 1 Opener (NC)

**11/02** 1 Normally open contact (NO), 1 Opener (NC) / 2 Opener (NC)

<b>12/00</b>	1 Normally open contact (NO), 2 Opener (NC) / -
<b>12/11</b>	1 Normally open contact (NO), 2 Opener (NC) / 1 Normally open contact (NO), 1 Opener (NC)
<b>12/02</b>	1 Normally open contact (NO), 2 Opener (NC) / 2 Opener (NC)
<b>02/01</b>	2 Opener (NC), - / 1 Opener (NC), -
<b>02/10</b>	2 Opener (NC), - / 1 Normally open contact (NO), -

(2)

*without* Latching force 5 N

**R** Latching force 30 N

(3)

*without* Power to unlock

**A** Power to lock

(4)

**1637** gold-plated contacts

(5)

**2197** Manual release for Power to unlock

## Documents

---

**Operating instructions and Declaration of conformity** (it) 571 kB, 27.11.2009

[http://www.schmersal.net/Bilddata/Azm/Pdf/Azm170/bedien/AZM170\\_170i/IT/mrl\\_azm170\\_170i\\_it.pdf](http://www.schmersal.net/Bilddata/Azm/Pdf/Azm170/bedien/AZM170_170i/IT/mrl_azm170_170i_it.pdf)

**Operating instructions and Declaration of conformity** (es) 592 kB, 27.11.2009

[http://www.schmersal.net/Bilddata/Azm/Pdf/Azm170/bedien/AZM170\\_170i/ES/mrl\\_azm170\\_170i\\_es.pdf](http://www.schmersal.net/Bilddata/Azm/Pdf/Azm170/bedien/AZM170_170i/ES/mrl_azm170_170i_es.pdf)

**Operating instructions and Declaration of conformity** (en) 671 kB, 27.11.2009

[http://www.schmersal.net/Bilddata/Azm/Pdf/Azm170/bedien/AZM170\\_170i/EN/mrl\\_azm170\\_170i\\_en.pdf](http://www.schmersal.net/Bilddata/Azm/Pdf/Azm170/bedien/AZM170_170i/EN/mrl_azm170_170i_en.pdf)

**Operating instructions and Declaration of conformity** (nl) 584 kB, 27.11.2009

[http://www.schmersal.net/Bilddata/Azm/Pdf/Azm170/bedien/AZM170\\_170i/NL/mrl\\_azm170\\_170i\\_nl.pdf](http://www.schmersal.net/Bilddata/Azm/Pdf/Azm170/bedien/AZM170_170i/NL/mrl_azm170_170i_nl.pdf)

**Operating instructions and Declaration of conformity** (jp) 769 kB, 27.11.2009

[http://www.schmersal.net/Bilddata/Azm/Pdf/Azm170/bedien/AZM170\\_170i/JP/mrl\\_azm170\\_170i\\_jp.pdf](http://www.schmersal.net/Bilddata/Azm/Pdf/Azm170/bedien/AZM170_170i/JP/mrl_azm170_170i_jp.pdf)

**Operating instructions and Declaration of conformity** (de) 572 kB, 27.11.2009

[http://www.schmersal.net/Bilddata/Azm/Pdf/Azm170/bedien/AZM170\\_170i/DE/mrl\\_azm170\\_170i\\_de.pdf](http://www.schmersal.net/Bilddata/Azm/Pdf/Azm170/bedien/AZM170_170i/DE/mrl_azm170_170i_de.pdf)

**Operating instructions and Declaration of conformity** (fr) 592 kB, 27.11.2009

[http://www.schmersal.net/Bilddata/Azm/Pdf/Azm170/bedien/AZM170\\_170i/FR/mrl\\_azm170\\_170i\\_fr.pdf](http://www.schmersal.net/Bilddata/Azm/Pdf/Azm170/bedien/AZM170_170i/FR/mrl_azm170_170i_fr.pdf)

**BG-test certificate** (en) 826 kB, 25.07.2006

[http://www.schmersal.net/Bilddata/Azm/Pdf/Azm170/baumuste/z\\_m17p02.pdf](http://www.schmersal.net/Bilddata/Azm/Pdf/Azm170/baumuste/z_m17p02.pdf)

**BG-test certificate** (de) 830 kB, 25.07.2006

[http://www.schmersal.net/Bilddata/Azm/Pdf/Azm170/baumuste/z\\_m17p01.pdf](http://www.schmersal.net/Bilddata/Azm/Pdf/Azm170/baumuste/z_m17p01.pdf)

**CCC certification** (en) 747 kB, 12.12.2006

[http://www.schmersal.net/Bilddata/Azm/Pdf/Azm161/zertifikat/q\\_371p02.pdf](http://www.schmersal.net/Bilddata/Azm/Pdf/Azm161/zertifikat/q_371p02.pdf)

**CCC certification** (cn) 725 kB, 12.12.2006

[http://www.schmersal.net/Bilddata/Azm/Pdf/Azm161/zertifikat/q\\_371p03.pdf](http://www.schmersal.net/Bilddata/Azm/Pdf/Azm161/zertifikat/q_371p03.pdf)

## Images

---

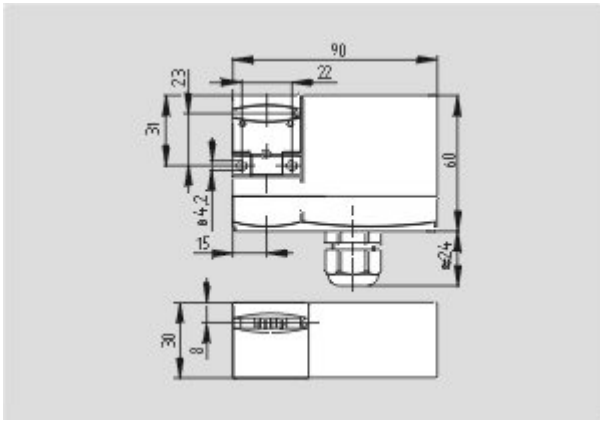

Dimensional drawing (basic component)

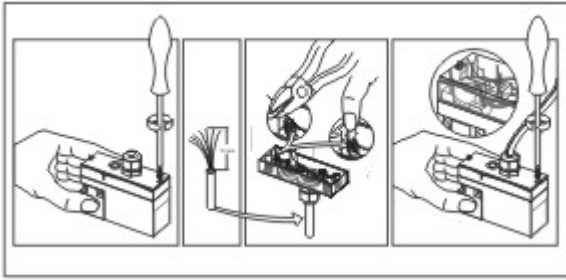

Assembly example

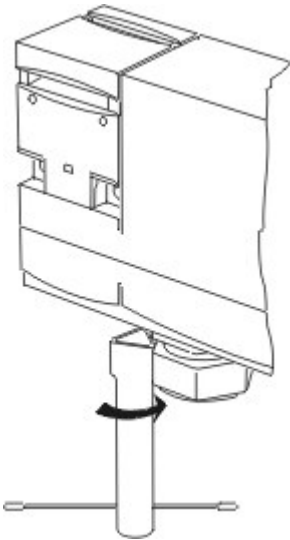

Detail photo

## System components

### Actuator



**1122893 - AZ 17/170-B1**

- Particularly suitable for sliding doors

**1137406 - AZ 17/170-B1-2245**

- Damps vibration on guard device



---

**1122895 - AZ 17/170-B5**

- Particularly suitable for hinged guards (front mounting)



---

**1139788 - AZ 17/170-B11**

- Particularly suitable for sliding doors



---

**1139789 - AZ 17/170-B15**

- Particularly suitable for hinged guards (front mounting)



---

**1123391 - AZM 170-B6**

- For very small actuating radii
- The direction of actuation can be selected by applicable insertion of the insert



---

**Accessories**

**1208493 - AZM 170-B CENTERING GUIDE**

- for AZ 17 and AZM 170

